

Sink Leonardo 40" x 20" 2B – U/M

Kitchen Sinks

Code: 1016 660

AISI 304 Stainless steel

Satin finish

Undermount

x cross bending for easy water draining

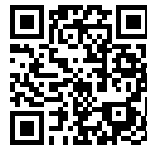

DETAILS

| | |
|------------------------|--|
| Edge/Installation Type | Undermount |
| Series | Leonardo |
| Texture | Satin |
| Material | AISI 304 stainless steel |
| Thickness | 16 Gauge (1.5 mm) |
| Overall dimensions | 39 ⁵ / ₈ " x 19 ⁵ / ₁₆ " |
| Bowls dimensions | 2 bowls 18 ³ / ₁₆ " x 15 ³ / ₄ " |
| Bowls depth | 10" |

| | |
|--------------------|---|
| Cut out | 38 ¹ / ₈ " x 17 ¹³ / ₁₆ " |
| Waste fitting type | 3 ¹ / ₂ " - with stainless steel basket |
| Bowls bottom | X cross bending for easy water draining |
| Underside | Protected with heavy duty undercoating |
| Fixing system | Undermount fixing kit (brass insert and clips) |

FEATURES

| | |
|-------------------------------------|--|
| Diamond-shape bottom | The draining of water is an important feature in a sink, and it's always taken good care of in Foster products. In the bent-welded sinks, which would have a flat bottom, the proper draining is guaranteed by the elegant beveling, which helps the water flow. |
| High thickness | 1.5 mm thick steel. A significant thickness, which guarantees the maximum sturdiness and durability. |
| Basket 3,5" waste fitting | The drain is equipped with a large 3.5" drain, with the practical basket cap that prevents the discharge of solid parts. |
| Triple recess - sliding accessories | The Foster Milano sink has an ingenious design that makes it simple to use a large set of optional accessories. On the topmost supporting step, the innovative Black grids slide, creating a large and practical surface to rinse food and crockery. The second step is meant to support and allow the sliding of a complete combination of accessories, which make some operations practical and safe: rinse, drain, slice, grate... everything can be done inside the sink. The third supporting step is on the bottom of the bowl. On this step one can rest the Black grids, making it possible to rinse foodstuffs without their coming in contact with the bottom of the sink, which may be dirty. |

TECHNICAL DATA

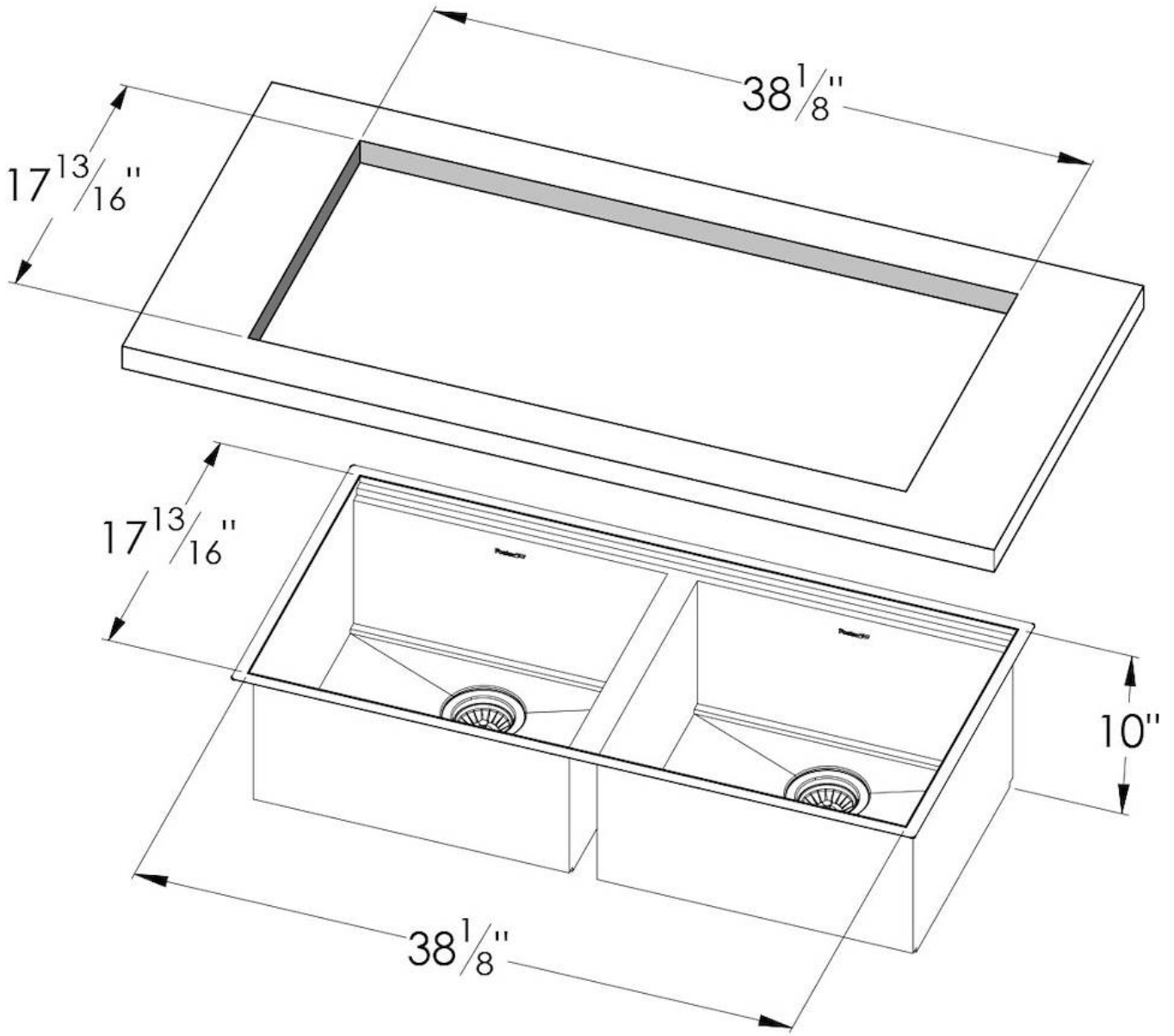

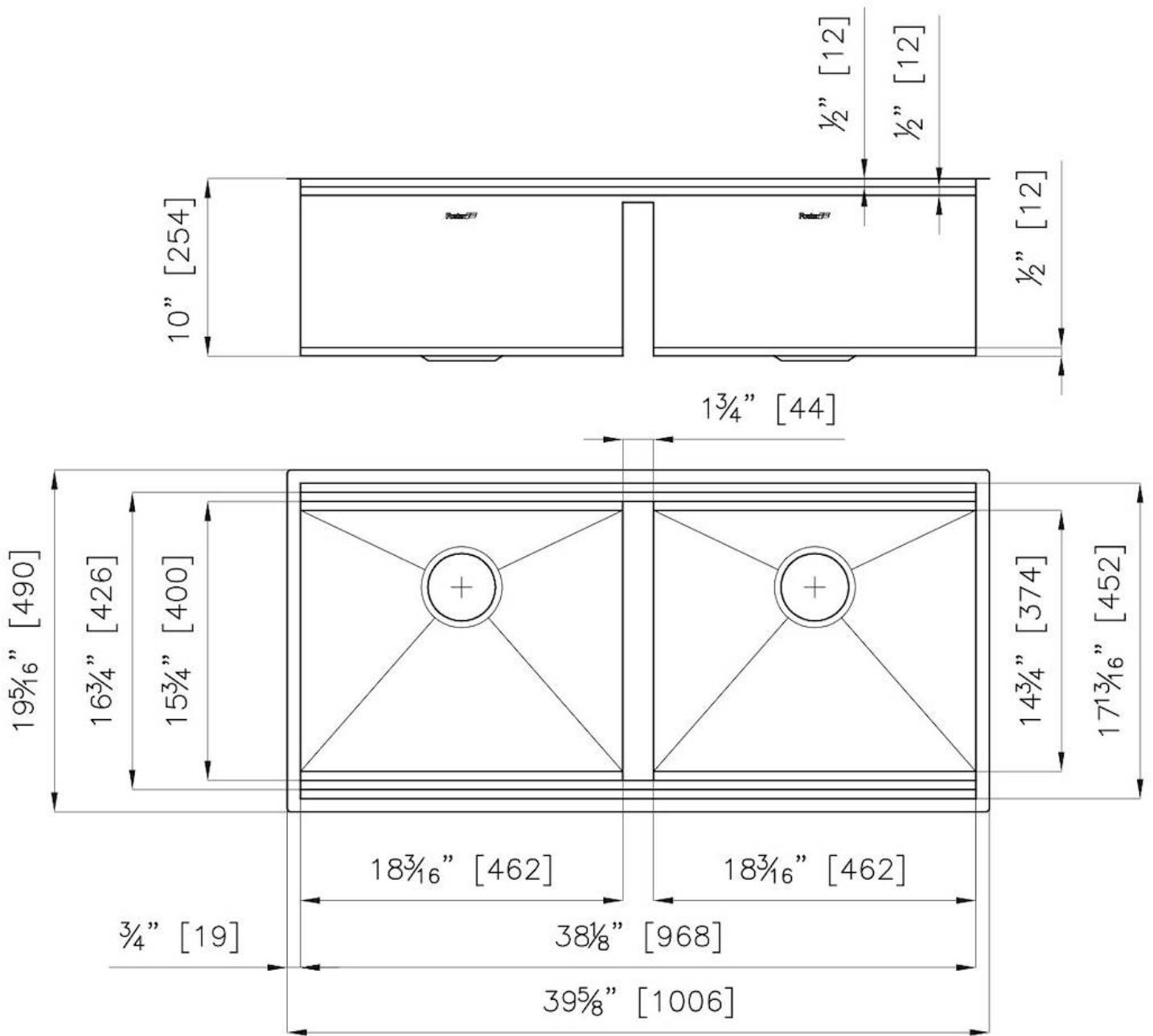

Leonardo Optional accessories

The "rails" system makes it possible to use a combination of numerous accessories. Grids, chopping boards, utensils' ranging system, bowls and containers of different dimensions can be alternated in the workspace with a simple gesture, and can easily be stacked, in order to be on hand at all times.

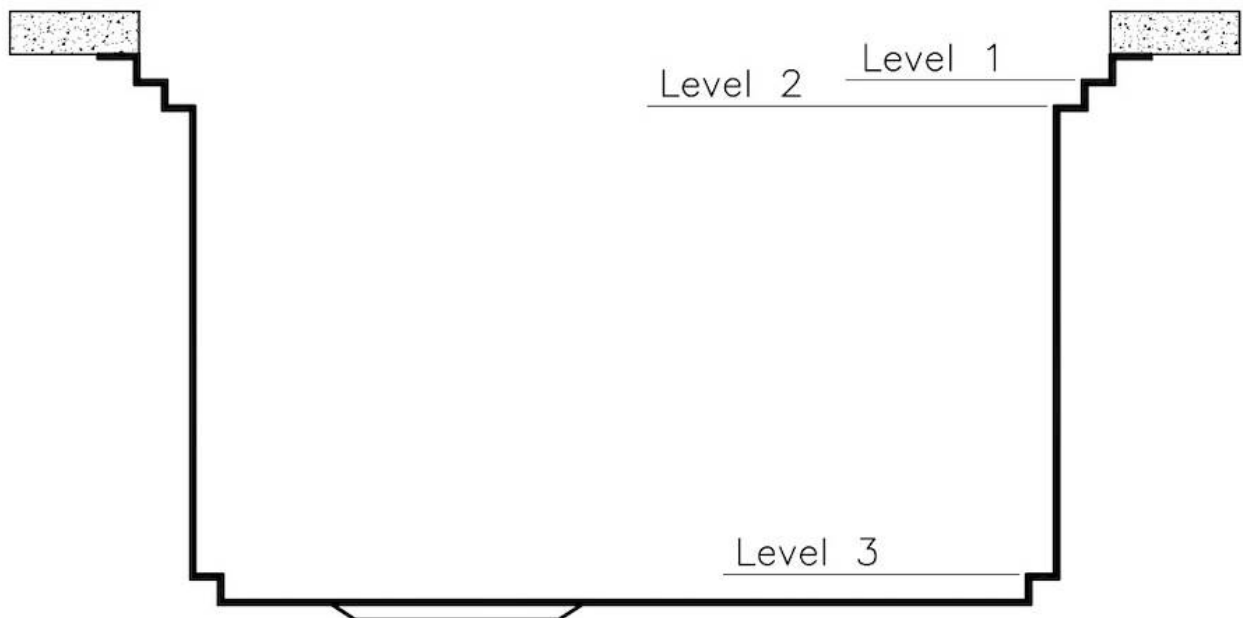

Leonardo Level 1

Compatible accessories:

8100 600
8100 601
8100 620
8100 621
8100 622
8642 000

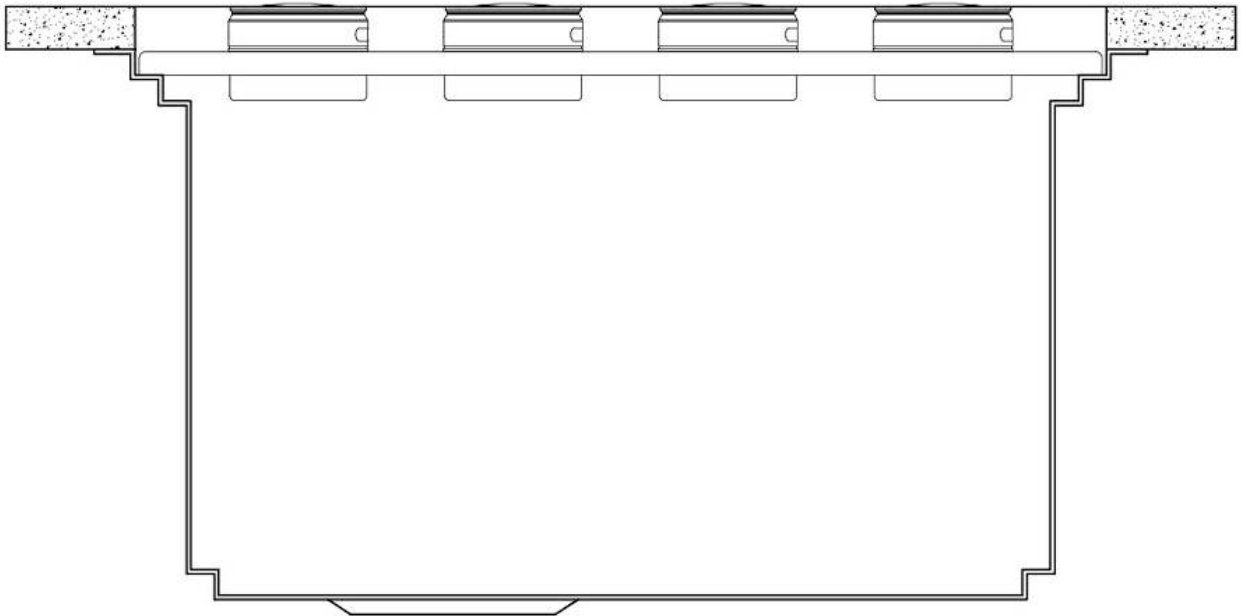

Leonardo Level 2

Compatible accessories:

8153 100

8631 300

8644 101



Leonardo Level 3

Compatible accessories:

8100 600



Edge
positioning

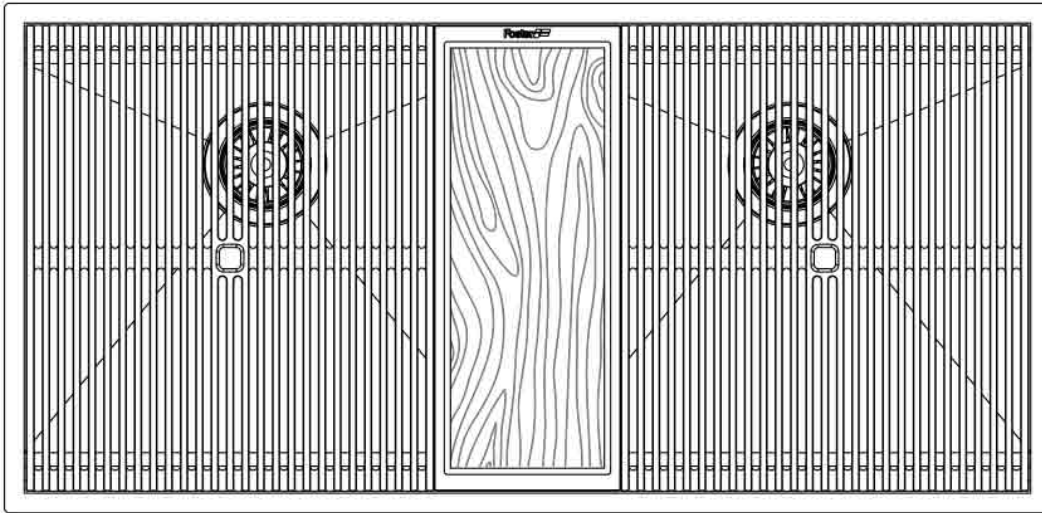

8100 600 8642 000 8100 600

8100 600

8100 600

Bottom
positioning

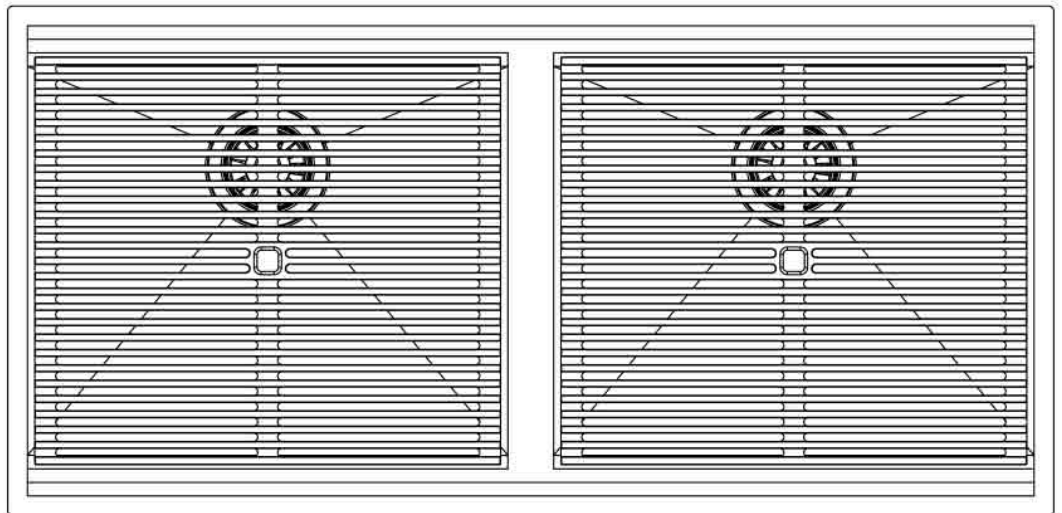

OPTIONAL ACCESSORIES



3 Bottles-holder set
8100 621



3 Bowls set
8100 622



4 Spices-holder set
8100 620



Black Grid
8100 600



Chopping Board
8642 000



Chopping Board
8631 300



Grating kit complete with ring support and food collection tray
8159 101
* only in combination with the accessory
8644 101

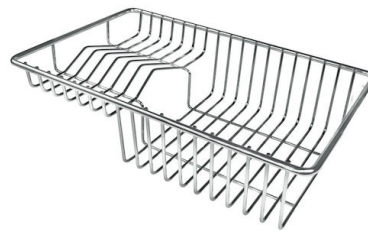

Stainless Steel dishes holder
8100 303
* only in combination with the accessory
8644 101



Stainless steel perforated pan
8151 000
* only in combination with the accessory
8644 101



Twin Chopping Board
8644 101



Waste disposer throat
8669 043



White bowl
8153 100

RECOMMENDED PAIRINGS



Faucet Capri
8467 005



Faucet Salina
8487 005



Milano Cooktop 6 burners
7639 900

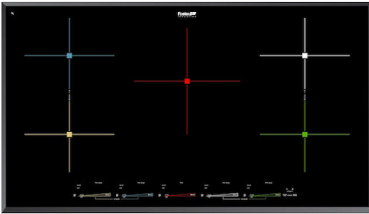

Milano Induction Cooktop 5 Plate
7390 945